

iXon^{EM}+ 897 (back-illuminated)



low-light imaging

Features & benefits

EMCCD Technology

Ultimate in Sensitivity from EMCCD gain – even single photon signals are amplified above the noise floor. Full QE of CCD chip is harnessed (no intensifier).

TE cooling to -100°C

Critical for elimination of darkcurrent detection limit.

RealGain™

Absolute EMCCD gain selectable directly from a linear and quantitative scale.

EMCAL™

Innovative user-initiated self-recalibration of EM Gain.

iCam

Unique innovation that empowers the EMCCD to operate with market-leading acquisition efficiency through live cell microscopy software.

> 90% QE back-illuminated sensor Maximum possible photon collection efficiency.

UltraVac™*1

Critical for sustained vacuum integrity and to maintain unequalled cooling and QE performance, year after year.

Variable readout rates up to 10 MHz

Quantitative accuracy at all speeds and slower readout rate for enhanced 16-bit dynamic range.

Selectable amplifier outputs – EMCCD and conventional

Highly flexible camera optimized for both fast, ultra low-light imaging and 'bright-field' or conventional fluorescence imaging.

High dynamic range and 16-bit digitization available

Extended sensor dynamic range (readout speed dependent) and matched digitization for quantization of dim and bright signals.

Minimal Clock-Induced Charge

Unique pixel clocking parameters, yielding minimized spurious noise floor.

Cropped sensor mode

Specialised acquisition mode for continuous imaging with fast temporal resolution

Enhanced Baseline Clamp

Essential for quantitative accuracy of dynamic measurements.

Built-in C-mount compatible shutter (optional)

Easy means to record control dark images- excellent for optimization of experimental set-up.

“Extracting the absolute best from EMCCD technology”

Andor's iXon^{EM}+ 897 back-illuminated EMCCD has single photon detection capability combined with >90% QE. iXon^{EM}+ is designed to extract the absolute best from quantitative EMCCD technology across all critical performance parameters.

This highly popular 512 x 512 frame transfer format delivers unequalled thermoelectric cooling down to -100°C, industry-lowest clock induced charge noise, and operates at 35 frames/sec (full resolution). Andor's rapid vertical shift capability gives distinct speed advantages when operated with binning/sub-array, whilst minimizing vertical smear. EMCCD and conventional CCD readout modes provide heightened application flexibility.

The absolute EM gain multiplication can be varied linearly from unity up to a thousand times directly via RealGain™, a true quantitative EM gain scale. To combat the gain-ageing phenomenon inherent to back-illuminated EMCCDs, Andor's EMCAL™ is a unique and innovative user-initiated routine, performing auto-recalibration of the EM Gain scale, without need for a light source, and circumventing the need for factory recalibration.



Camera overview

Active Pixels	512 x 512
Pixel Size (W x H; μm)	16 x 16
Image Area (mm)	8.2 x 8.2
Active Area Pixel Well Depth (e ⁻)	
Typical	160000
Maximum	220000
Gain Register pixel well depth (e ⁻ , typical)	800000*2
Max Readout Rate (MHz)	10
Frame Rates (frames per sec)	35 - 549
Read Noise (e ⁻)	< 1 to 49 @ 10 MHz

Quantum efficiency*3

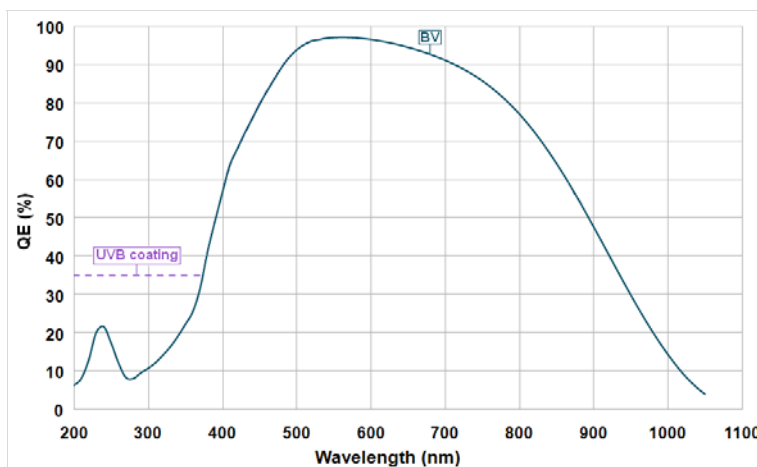

Peak Quantum Efficiency (%)

CCD Type	Typical
BV @ 575 nm	92.5

Technical specifications

System characteristics

Pixel Readout Rate (MHz)	
Electron Multiplying Amplifier	10, 5, 3, 1
Conventional Amplifier	3 & 1
Digitization	True 14-bit @ 10, 5, 3 & 1 MHz readout rate (16 bit available @ 1 MHz)
Vertical Clock Speed (μs)	0.3 to 3.3 (variable)
Linear Absolute Electron Multiplier Gain	1 - 1000 times (software controlled)
Linearity (% maximum)*⁴	1
Triggering	Internal, External, External Start
Camera window type	Single window with double-sided AR coating (standard for BV model)

System Readout Noise (e⁻)*⁵

	Typical	With Electron Multiplication
10 MHz through EMCCD amplifier	49	<1
5 MHz through EMCCD amplifier	42	<1
3 MHz through EMCCD amplifier	32	<1
1MHz (16-bit) through EMCCD amplifier	21	<1
1MHz (16-bit) through Conventional amplifier	6	N/A

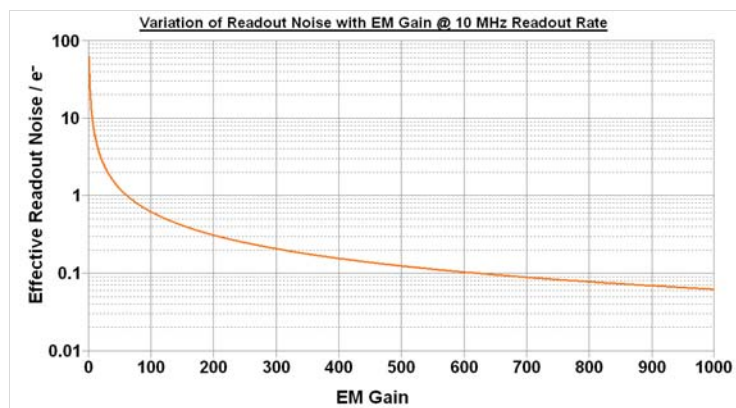

Minimum sensor temperatures (typical)

Air cooled (ambient air at 20°C)	-85°C
Water cooled using Re-circulator (ambient air @ 20°C)	-90°C
Water cooled using Chiller (@ 10 °C, 0.75 l / min)	-100°C

Dark Current & Background Events

Dark Current @ -85°C (e⁻/pix/sec)*⁶	0.001
EMCCD-Amplified Background Events*⁷ (events/pix @ 1000 x gain and -85°C)	0.005

Blemish specification

As defined by the sensor manufacturer e2v. Can be accessed in the CCD97 back-illuminated sensor datasheet, downloadable from this web page: <http://www.e2v.com/module/page-357/13-vision-datasheets-and-technical-notes.cfm>

Full frame rate*⁸

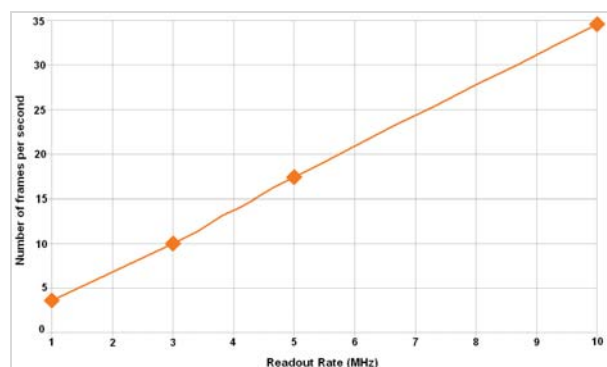

Max frames per second*⁹

Binning	Array size			
	512 x 512 (Full Frame)	256 x 256	128 x 128	512H x 100V
1 x 1	35	68	132	168
1 x 2	68	132	248	313
2 x 2	68	132	248	313
1 x 4	131	246	439	549
4 x 4	131	246	439	549

Computer requirements

To handle data transfer rates of 10 MHz readout over extended kinetic series, a powerful computer is recommended, e.g.:

- 3 GHz Pentium (or better)
- 1GB RAM
- 10,000 rpm SATA hard drive preferred for extended kinetic series
- PCI-compatible computer. PCI slot must have bus master capability.
- Available auxiliary internal power connector
- 32 MB free hard disc space

Operating & storage conditions

Operating Temperature	0°C to 30°C ambient
Relative Humidity	< 70% (non-condensing)
Storage Temperature	-25°C to 55°C

Power requirements*¹⁰

- 0.6A @ +12V
- 0.3A @ -12V
- 3.0A @ +5V

Need more information? Please contact us at:

International Office	US Office
Phone: +44 28 9023 7126	Phone: 800.296.1579
Fax: +44 28 9031 0792	Fax: 860.290.9566
Japanese Office	Chinese Office
Phone: +81 3 3511 0659	Phone: +86-10-5129-4977
Fax: +81 3 3511 0662	Fax: +86-10-6445-5401

Ordering information & notes

To order the camera you require, please use the following ordering system:

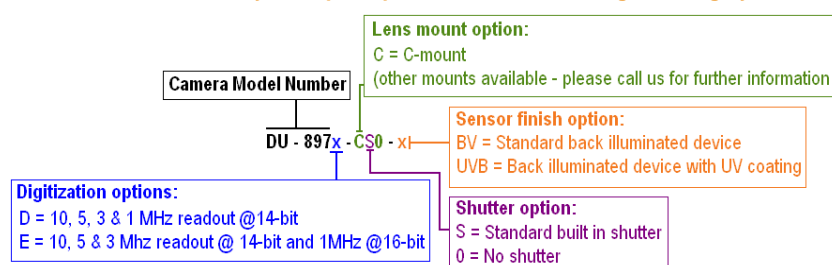

E.g. a **DU-897D-CSO-UVB** is a **back-illuminated iXon^{EM}+ 897** camera with **14-bit digitization** at 10, 5, 3 and 1MHz readout speeds, **EMCCD & Conventional** output amplifiers, **standard shutter** and **UV-enhanced coating**.

The iXon^{EM}+ 897 requires the following controller card:

CCI-23 PCI controller card

The iXon^{EM}+ 897 also requires one of the following software options:

Andor Solis (i)	A ready-to-run Windows 2000 or XP-based package with rich functionality for data acquisition and processing.
Andor SDK	A DLL driver and software development kit that let you create your own applications for the Andor Camera. Available for Windows 2000 or XP and Linux.
Andor iQ	A comprehensive multi-dimensional imaging software package. Offers tight synchronization of EMCCD with a comprehensive range of microscopy hardware, along with comprehensive rendering and analysis functionality. Modular architecture for best price/performance package on the market.
Third party software compatibility	Drivers are available so that the iXon ^{EM} + range can be operated through a large variety of third party imaging packages.

The following accessories are available for use with the iXon^{EM}+ 897:

XW-RECR	Re-circulator for enhanced cooling performance
XW-CHIL-150	Chiller/re-circulator for maximum cooling performance
REMOTE CTRL KIT	Programmable remote control for controlling functions from anywhere around the optical set-up

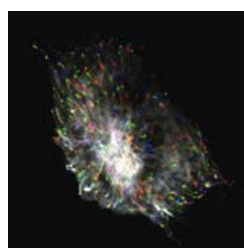

Composite triple color image of a microtubule protein (EB1-GFP) imaged with objective-type TIRFM (60x 1.45NA), incorporating the iXon DV887 back-illuminated running at 0.5 frames/sec.

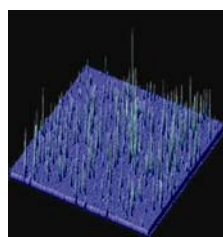

Single Cy3 molecules immobilized on a glass surface, imaged by objective-type TIRFM using the Andor iXonEM DU-897 back-illuminated EMCCD; exposure time 30ms.

Specifications are subject to change without notice

- ◆ 1 Assembled in a state-of-the-art Class 10,000 cleanroom facility, Andor's UltraVac™ vacuum process combines a permanent hermetic vacuum seal (no o-rings), with a stringent protocol to minimize outgassing, including use of proprietary materials. Outgassing is the release of trapped gases that would otherwise prove highly problematic for high-vacuum systems.
- ◆ 2 The EM register on CCD97 sensors has a linear response up to 400,000 electrons max. and a full well depth of ~ 800,000 electrons max.
- ◆ 3 Quantum efficiency of the CCD sensor as measured by the CCD Manufacturer. Can be accessed in the CCD97 back-illuminated sensor datasheet, downloadable from this web page: <http://www.e2v.com/module/page-357/13-vision-datasheets-and-technical-notes.cfm>.
- ◆ 4 Linearity is measured from a plot of Counts vs. Signal up to the saturation point of the system. Linearity is expressed as a percentage deviation from a straight line fit.
- ◆ 5 System Readout noise is for the entire system. It is a combination of CCD readout noise and A/D noise. Measurement is for Single Pixel readout with the CCD at a temperature of -85°C and minimum exposure time under dark conditions. Under Electron Multiplying conditions, the effective system readout noise is reduced to sub 1e⁻ levels. Noise values will change with **pre-amplifier gain (PAG)** selection. Values quoted are measured with highest available PAG setting.
- ◆ 6 This value is obtained using the traditional method of measuring dark current, as for any CCD camera, i.e. taking a long integration time (with no EM gain applied) to get a darksignal that is well above the read noise. The dark current measurement is averaged over the CCD area excluding any regions of blemishes.
- ◆ 7 Using Electron Multiplication (EM) the iXon^{EM}+ is capable of detecting single photons, therefore the true camera detection limit is set by the number of 'dark' background events. These background events consist of both residual thermally generated electrons and Clock Induced Charge (CIC) electrons (also referred to as Spurious Charge), each appearing as random single spikes that are well above the read noise floor.
A thresholding scheme is employed to count these single electron events and is quoted as a probability of an event per pixel. Acquisition conditions are full resolution and max frame rate (10 MHz readout; frame-transfer mode; 0.5 μs vertical clock speed; x 1000 EM gain; 30 ms exposure; -85°C). It is important to realise that to get to this single photon detection regime there must be sufficient cooling, such that there is significantly less than 1 event per pixel
- ◆ 8 The graph shows the full frame rates possible when reading out the sensor at 10, 5, 3 and 1 MHz pixel readout rates, and using 0.3μs vertical clock speed.
- ◆ 9 The max frames / second for iXon^{EM}+ imaging CCDs is the maximum speed at which the device can acquire images in a standard system. Shown are the frame rates at 10 MHz digitization rates for a range of binning or array size combinations. All measurements are made with 0.3μs vertical clock speed. It also assumes internal trigger mode of operation
- ◆ 10 These power requirements are the maximum load that will be drawn from the computer for the camera head and controller card combined.

Dimensions

Weight: 3.4 kg [7.5 lb]

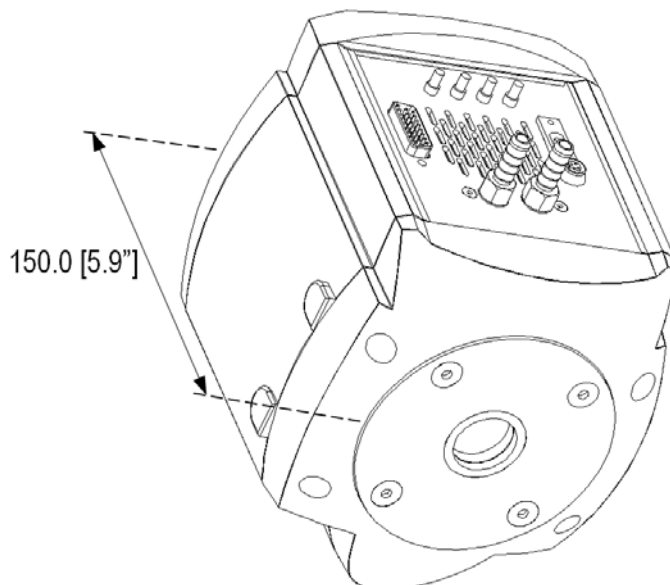
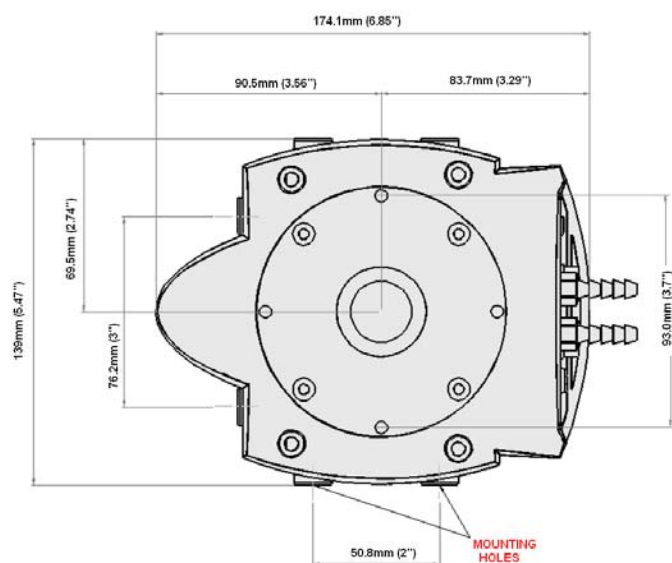

Notes:

1. The clearance from the C-mount face plate to the shutter is 6mm. Please ensure that when fitting a lens, to a system with a built in shutter, that it does not extend into the housing by more than 5mm.
2. There are mounting holes (¼-20UNC) located on three sides of the camera. They are positioned centrally at a distance of 40mm from the front of the front face.

Connections

